

UK Manual de Instruções

http://www.arcmanuals.com/MANUAL_A4_UK.pdf

Arcaboa Super ARV125E Instruction Manual



Instructions Manual - Contents











































































Warning for appliances with cooling agent R290	1
General Warnings / Wood storage and packaging	2/3
1. Instructions for Installation and Use	4
1.1 Installation of appliance	4
1.2 Operating Temperature	4
2. Use	4
2.1 Introduction of Frozen product	4/5
2.2 Electrical Connection	5
2.2.1 Connection of LED lighting via extra cable	5
2.2.2 Data cable	6
3. Installation and Commissioning	6
4. Control Panel	6
4.1 Appliance with mechanical thermostat	6
4.2 Appliance with DIXELL electronic temperature control	6/7
4.2.1 Definition of Keys	7
4.2.2 Temperature Setting	7
4.2.3 Change of Unit of Measure	7
4.2.4 Real Time Clock Setting	7
4.2.5 Alarm Information	7
4.2.6 Change of operating temperature range	8
4.3 Electronic Temperature Controller, DANFOSS model	8
4.3.1 Definition of Keys	8
4.3.2 Change of Temperature Values	8
4.3.3 Change of Temperature Unit	8
4.3.4 Change of operating temperature range	8
4.3.5 Internal reset of controller / Factory Settings	8
4.3.6 Real Time Clock Setting	8/9
4.3.7 Alarm Information	9
5. Defrosting	9
5.1 Real Time Clock Programmed Automatic Defrosting	9
5.1.1 Defrosting with DANFOSS AK-CC 210 A Controller	9
5.1.2 Defrosting with DIXELL XR 77 CX Controller	10
5.2 Appliances without Defrosting	10
6. Maintenance / Cleaning	10
6.1 Exterior Cleaning	10
6.2 Interior Cleaning	10
6.2.1 Appliances with Semi-Automatic Defrosting	10/11
6.2.2 Appliances with Automatic Defrosting	11
6.2.2.1 Vertical Cabinet (mod. ARV 2.5DE)	12
6.3 Cleaning of the Plastic Lid frame	12
6.4 Cleaning of the Condenser	12/13
6.5 Cleaning of Glass	13
6.5.1 Exterior cleaning	13
6.5.2 Interior Cleaning	13
6.6 Replacement of Led Lighting	13
6.7 Replacing the Led Transformer	14
7. Packaging of the Product	14
7.1 Interior	14
7.1.1 Appliances without Defrosting	14
7.1.2 Appliances with Automatic Defrosting	14
7.2 Exterior	14/15
7.3 ARV 2.5 Vertical Cabinet Fixing Bracket	15
7.3.1 Attachment Structure	15
7.3.2 Transport and Raising the Appliance Into Position	15
7.3.3 Attachment of the Appliance's Support	15/16
7.3.4 Attachment of the Structure to the Wall	16
8. Regulations and Standardisation	16

Instructions Manual

« S U P E R M A R K E T » Commercial Use Freezer	R134 a	R290	DEFROSTING	LED	OPERATION	DIMENSIONS (mm)
750 CHV/V	●	○	○ ■	■	Freezing	1550 x 960 x 780
750 CHV/V R	○	●	○ ■	■	Freezing	1550 x 960 x 780
900 CHV/V	●	○	○ ■	■	Freezing	2050 x 960 x 780
900 CHV/V R	○	●	○ ■	■	Freezing	2050 x 960 x 780
1100 CHV/V	●	○	○ ■	■	Freezing	2050 x 960 x 780
1100 CHV/VR	○	●	○ ■	■	Freezing	2500 x 960 x 780
SUPER	●	○	○	●	Freezing	
SUPER R	○	●	○	●	Freezing	
SUPER D	●	○	semi-automatic	●	Freezing	SUPER 1.5: 1520 x 920x 790
SUPER D R	○	●	semi-automatic	●	Freezing	SUPER 2:
SUPER DE	●	○	automatic	●	Freezing	2020 x 920 x 790
SUPER D RE	○	●	automatic	●	Freezing	SUPER 2.5:
SUPER DPN	●	○	semi-automatic	●	Freezing/Cooling	2500 x 920 x 790
SUPER DPN R	○	●	semi-automatic	●	Freezing/Cooling	
SUPER DPNR E	○	●	automatic	●	Freezing/Cooling	
PANORAMICA 2	●	○	○	●	Freezing	2020 x 920 x 830
PANORAMICA 2 R	○	●	○	●	Freezing	2020 x 920 x 830
PANORAMICA 2D R	○	●	semi-automatic	●	Freezing	2020 x 920 x 830
PANORAMICA 2 D RE	○	●	automatic	●	Freezing	2020 x 920 x 830
PANORAMICA 2 DPN	●	○	semi-automatic	●	Freezing/Cooling	2020 x 920 x 830
PANORAMICA 2 DPN R	○	●	semi-automatic	●	Freezing/Cooling	2020 x 920 x 830
PANORAMICA DPN RE	○	●	automatic	●	Freezing/Cooling	2020 x 920 x 830
SUPER TOPO D	●	○	semi-automatic	●	Freezing	1990 x 920 x 790
SUPER TOPO D R	○	●	semi-automatic	●	Freezing	1990 x 920 x 790
SUPER TOPO D RE	○	●	automatic	●	Freezing	1990 x 920 x 790
SUPER TOPO DPN	●	○	semi-automatic	●	Freezing/Cooling	1990 x 920 x 790
SUPER TOPO DPN R	○	●	semi-automatic	●	Freezing/Cooling	1990 x 920 x 790
SUPER TOPO DPN RE	○	●	automatic	●	Freezing/Cooling	1990 x 920 x 790
PANORAMICA TOPO	●	○	semi-automatic	●	Freezing/Cooling	1965 x 920 x 830
PANORAMICA TOPO DR	○	●	semi-automatic	●	Freezing	1965 x 920 x 830
PANORAMICA TOPO D RE	○	●	automatic	●	Freezing	1965 x 920 x 830
PANORAMICA TOPO DPN	●	○	semi-automatic	●	Freezing/Cooling	1965 x 920 x 830
PANORAMICA TOPO DPN R	○	●	semi-automatic	●	Freezing/Cooling	1965 x 920 x 830
PANORAMICA TOPO DPN RE	○	●	automatic	●	Freezing/Cooling	1965 x 920 x 830
DUPLA D R	○	●	semi-automatic	●	Freezing	2150 x 1465 x 930
DUPLA DRE	○	●	automatic	●	Freezing	2150 x 1465 x 930
DUPLA DPN R	○	●	semi-automatic	●	Freezing/Cooling	2150 x 1465 x 930
DUPLA DPN RE	○	●	automatic	●	Freezing/Cooling	2150 x 1465 x 930
CEP 2 D	●	○	semi-automatic	●	Freezing	2000 x 880 x 940
CEP 2 DPN	●	○	semi-automatic	●	Freezing/Cooling	2000 x 880 x 940
CEP 2 D R	○	●	semi-automatic	●	Freezing	2000 x 880 x 940
CEP 2 DPN R	○	●	semi-automatic	●	Freezing/Cooling	2000 x 880 x 940
CEP 1.5 D	●	○	semi-automatic	●	Freezing	1500 x 880 x 940
CEP 1.5 DPN	●	○	semi-automatic	●	Freezing/Cooling	1500 x 880 x 940
CEP 2	○	●	○	●	Freezing	1500 x 880 x 940
CEP 2 R	●	○	○	●	Freezing	2000 x 880 x 940
CEP 1.5	○	○	○	●	Freezing	1500 x 880 x 940
CEP 1.5 R	○	○	○	●	Freezing	1500 x 880 x 940
CEP TOPO D	●	○	semi-automatic	●	Freezing	1770 x 840 x 900
CEP TOPO D R	○	●	semi-automatic	●	Freezing	1770 x 840 x 900
CEP TOPO DPN	●	○	semi-automatic	●	Freezing/Cooling	1770 x 840 x 900
CEP TOPO DPN R	○	●	semi-automatic	●	Freezing/Cooling	1770 x 840 x 900
ARV 2.5 DE	○	●	automatic	●	Freezing	2505 x 1005 x 670

○ No ● Yes ■ Optional

Instructions Manual

«HORECA» Commercial/Home Use	R134 a	R290	TYPE OF LIDS	LED	OPERATION	DIMENSIONS (mm)
210 CHV R 			Lifting Opaque		Freezing	800 x 600 x 870
320 CHV R 			Lifting Opaque		Freezing	1110 x 600 x 870
430 CHV R 			Lifting Opaque		Freezing	1410 x 600 x 870
550 CHV R 			Lifting Opaque		Freezing	1810 x 600 x 870
700 CHV R 			Lifting Opaque		Freezing	1910 x 700 x 870
210 CHV/V			Sliding - Glass		Freezing	800 x 600 x 820
210 CHV/V R			Sliding - Glass		Freezing	800 x 600 x 820
320 CHV/V			Sliding - Glass		Freezing	1110 x 600 x 820
320 CHV/ V R			Sliding - Glass		Freezing	1110 x 600 x 820
430 CHV/V			Sliding - Glass		Freezing	1410 x 600 x 820
430 CHV/V R			Sliding - Glass		Freezing	1410 x 600 x 820
550 CHV/V			Sliding - Glass		Freezing	1810 x 600 x 820
550 CHV/V R			Sliding - Glass		Freezing	1810 x 600 x 820
700 CHV/V			Sliding - Glass		Freezing	1910 x 700 x 820
700 CHV/V R			Sliding - Glass		Freezing	1910 x 700 x 820
320 CHV/TC R 			Sliding - Opaque		Freezing	1110 x 600 x 820
430 CHV/TC R 			Sliding - Opaque		Freezing	1410 x 600 x 820
550 CHV/TC R 			Sliding - Opaque		Freezing	1810 x 600 x 820
ALFA 1100 R 			Sliding - Opaque		Cooling	1110 x 600 x 820
ALFA 1400 R 			Sliding - Opaque		Cooling	1410 x 600 x 820
ALFA 1800 R 			Sliding - Opaque		Cooling	1810 x 600 x 820

○ Não ● Sim ■ Opcional  Home Use

The appliances marked with the symbol  in the table above are considered under the specific household appliances standard. These appliances must be used in household and similar applications, such as:

- Kitchen areas reserved for staff of shops, workshops and other professional environments.
- Cottages and for use by the clients of hotels, motels, holiday homes and other residential and typical household environments.
- Hotel room type environments.
- catering and other similar applications, except retail.

 **WARNING!** These appliances can be used by children from 8 years of age or older and by people with reduced physical, sensory or mental abilities, or lack of experience and knowledge if they are supervised or have received instructions on how to use the devices in a safe way, and they understand the risks involved.

- children must not play with the appliance.
- children aged from 3 to 8 years can charge and disconnect the chilling appliance.

Warnings for appliances with cooling agent R290 General Warnings

IMPORTANT!

Appliances with the «R» designation on the model, and the symbol  on the data plate, means that the cooling gas used in the cooling system is PROPANE - R290 and highly inflammable.

 **ATTENTION!** Electrical and/or cooling system installation may only be carried out by duly qualified people. In the event of failure to meet this condition, the manufacturer will not be held liable for any problems caused, as well as any right to claim under the warranty.

The cooling fluid R290 (CH₃CH₂CH₃) (propane) is classified in accordance with standard EN378-1, in the group of inflammable and explosive refrigerants, with a GWP=3 (Global Warming Potential) and ODP=0 (Ozone Depletion Potential).

R290 is a natural gas and harmless to the environment, however it always requires some precautions due to its inflammability:

- 1- Your freezer owes, in part, its proper functioning to the forced ventilation with which it is equipped. However, air circulation obstruction, located in the front, rear and/or side can compromise the efficiency and safety of your appliance.
- 2- To install the appliance, an essential condition for its proper functioning and safety is a well-ventilated and spacious location, where air circulation is never restricted.
- 3- The work undertaken should only be carried out by specialised technicians with appropriate training.
- 4- Do not use mechanical and/or electrical devices to speed up the defrosting process. Remove the ice with the scraper that is provided with the instructions manual, so as to avoid damaging the cooling circuit.
- 5- Do not use electrical equipment inside your appliance.
- 6- When carrying out repairs, whenever you have to open the cooling circuit, make sure that it is opened in a well-ventilated location or outdoors. Any repairs must only begin after ensuring that there is no gas in the circuit.
- 7- If any electrical system is used, whether for maintenance and/or repairs, it must be in conformity with the ATEX directive and comply with the minimum safety requirements for use in potentially explosive atmospheres.
- 8- No explosive substances such as aerosols containing flammable propellants must be kept inside this appliance.



Fire Risk / Flammable Materials

General Warnings

To avoid the risk of accidents and damage to the appliance, please read these instructions before installation and before using it for the first time. They contain important notes on the safety, operation and care of your appliance. Keep these instructions in a safe place for future use!

Informação! Emission sound pressure level is below 70 dB

SAFETY INDICATIONS / WARNINGS

⚠ ATTENTION! Do not store explosive substances such as aerosols containing flammable propellants in this appliance.

VERY IMPORTANT:

Whenever you wish to clean the outer casing of your appliance, never do it directly with water. Water or humidity in the electrical circuit can seriously damage

- When cleaning the floor, be careful not to splash water on or in the vicinity of the appliance. Observance of this rule may avoid the risk of serious damage to the appliance.
- Do not use mechanical devices or other devices to speed up the defrosting process. Remove the ice as recommended, so as to avoid damaging the cooling circuit. See explanation in the Maintenance/Cleaning chapter.

VERY IMPORTANT: The plastics of the appliances must not be cleaned with cleaning products that contain ammonia or solvents. Always use neutral soap based products.

- Before connecting the appliance, make sure that the connection data (voltage and frequency) on the data plate match the local mains electricity supply. (see example of Fig. 1)

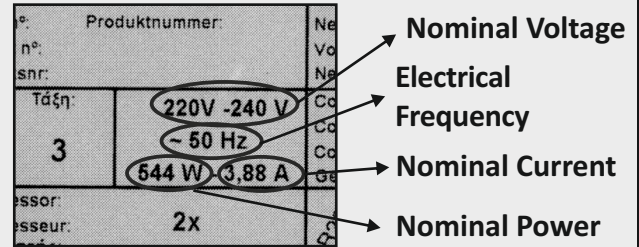

Figure 1

The data plate is positioned at the rear of the appliance which contains more important technical data, such as:

- Appliance model
- Serial number
- Climate class
- Type of coolant used and quantity
- Name and address of the manufacturer or authorized representative.

In addition, at the front of the appliance next to the frame there is a small sticker that indicates the model of the appliance.

General Warnings

WARNING! Do not use multiple portable plugs or portable power supplies at the back of the appliance.



These do not guarantee the required safety of the appliance (e.g. danger of overheating).

NOTE! Your appliance is only disconnected from the electricity supply when the connection plug is disconnected from the wall socket.

Before undertaking any maintenance or repair work, remove the plug from the electrical socket.

VERY IMPORTANT: The appliance must be positioned in such a way as to ensure quick and easy access to the socket and when the plug is removed it must be placed in such a way that the operator can check, from any of the points to which he/she has access, that the plug is still removed.

WARNING! When positioning the appliance, make sure that the power cord is not trapped or damaged.

⚠ ATTENTION! The electrical safety of this appliance can only be guaranteed when it is correctly earthed and has its own current circuit.

VERY IMPORTANT:

Any servicing, including the replacement of lighting, or replacement of the power cable must be performed by the after-sales service in order to prevent danger.

⚠ ATTENTION! Do not expose this appliance to direct sunlight.

According to its climate class, do not install the appliance in environments where the temperature/humidity does not correspond to the class indicated on the data plate. See point 1.2 on the following page.

Wood Storage/Packaging

The equipment was inspected at the time of packaging at the factory. Any claim of damage must be made to the transport company. The transport company will provide all the necessary documents.

Receiving and Inspection of Equipment (Transport/Packaging)

⚠ WARNING!

All equipment shall be inspected visually before and during unloading.

To prevent damage during handling or transportation, do not remove the packaging from the equipment until it reaches the final place of installation.

To maintain the quality assurance of the products in the packaging, avoid their exposure to high temperatures and/or direct sunlight. Refer to item 1.2 on the next page

Place the pallet on a levelled and firm surface. Inspect the equipment for visible

VERY IMPORTANT:

The device must always be moved, used and/or transported in a horizontal position.

Manufacturer's name and address:

ARCABOA - Industria de frio, s.a.
R. Do Lordelo
4510 - 591 - Fânzeres.
PORTUGAL

Instructions Manual

1- INSTRUCTIONS FOR INSTALLATION AND USE:

1.1 - INSTALLATION OF YOUR APPLIANCE

When installing the appliance, the following precautions must be taken:

- The pavement should be completely level, so as to permit the feet to be laid firmly flat.
- A key condition for the proper operation of the appliance is that it be placed in a well-ventilated room and not exposed to direct sunlight or any other source of heat. Figure 2 indicates the distance between appliances in a plug-in joint.

⚠ ATTENTION! In an individual installation, the distance between the appliances and the nearest walls or furniture/ shelves must be at least 150 mm.

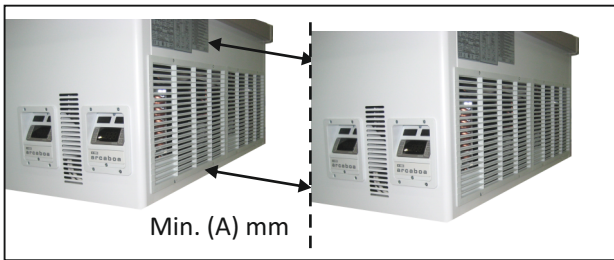
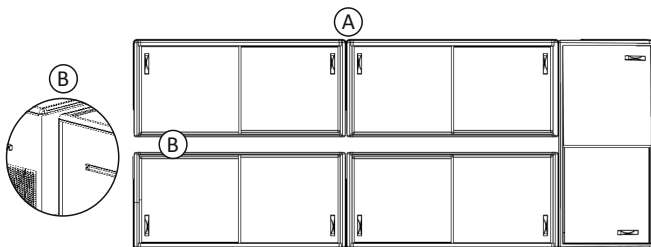

Figure 2

- Model CHV/V : (A) = 50 mm
- Model SUPER : (A) = 20 mm
- Model PANORAMICA: (A) = 20 mm
- Model CEP: (A) = 50 mm
- Model DUPLA: (A) = 20 mm

■ The gaps in the corridor where two (B) appliances are joined cannot be covered up, unless special bore grilles supplied by the manufacturer are used.



■ In a PLUG-IN installation of several appliances, always comply with the configuration indicated by the manufacturer.

■ The appliance you have purchased partly owes its good functioning to the forced ventilation it is equipped with. However, obstructing the air flow around the rear, side or top grille (mod. ARV) depending on the model, may reduce the normal efficiency of your appliance.

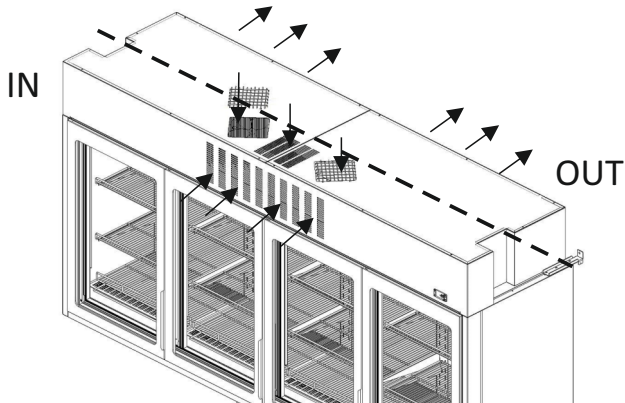

■ Do not place thick advertising boards on the outer casing. The boards can only be placed on thin film and so as to never cover up the air inlets of the appliance.

■ Avoid air currents and heat radiation in the room where the appliance is installed. Any heat radiation in the vicinity of the appliance will lower its energy efficiency and raise energy costs.

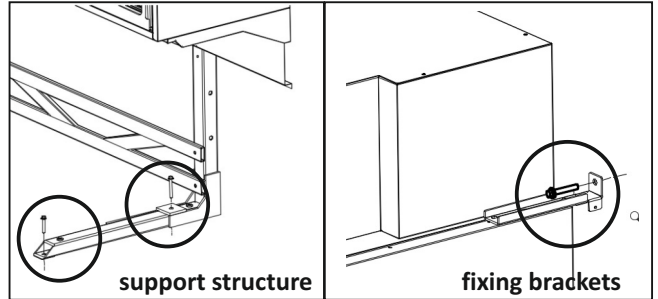

VERY IMPORTANT!

The support structure of the vertical cabinet (model ARV) must be attached to the floor and the side fixing brackets must be attached to the wall.

■ The appliance that you purchased owes, in part, its proper functioning to the forced ventilation with which it is equipped. However, obstruction of air circulation, through the rear or side grille, depending on the model, can undermine the normal efficiency of your appliance.

1.2- OPERATING AND STORAGE TEMPERATURE

The ambient room temperature where the appliance is going to be installed must not exceed 32°C or drop below 16°C.

The temperature in the warehouse or during transport must not exceed 55°C. Danger of deformation of plastics.

⚠ NOTE! To guarantee the temperature at load limit the appliance must be installed in a room according to its range. This information is indicated in the data plate of the appliance, example;

■ **CLASS 3L1:** Maximum ambient room temperature of +25°C / Relative Humidity less/equal to 60%

■ **CLASS 4L1:** Maximum ambient room temperature of +30°C / Relative Humidity less/equal to 55%

⚠ NOTE! If the % relative humidity values are equal to 60 +/- 5%, condensation may appear on the glass covers. In these situations, we recommend leaving the low consumption LED lighting on at all times or regularly cleaning the covers with absorbent paper.

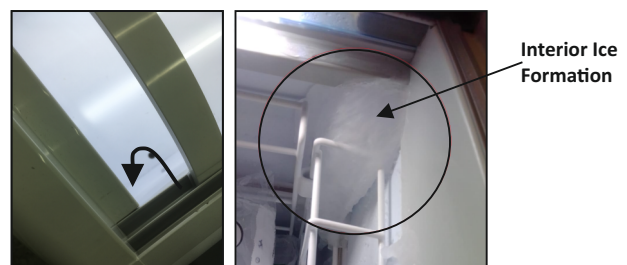

Instructions Manual

VERY IMPORTANT!

Always remove the condensation water accumulated on the glass covers. Otherwise the water from condensation will settle in the plastic profile where the cover fits and ice will accumulate over time in the front corners of your

2- USE

The appliance which you purchased is designed to store previously frozen and/or chilled food products depending on the appliance model that you purchased. The differences between the models are:

- model : Freezing
- model + D : | Freezing
| Automatic Defrosting
- model + PN: | Freezing
| Cooling
- model + DE: | Freezing
| Automatic Defrosting with Water Evaporation (Diagram fig.4 / fig. 4.1)

2.1 - PLACIE THE PRODUCTS

Before placing frozen food in the appliance, you must:

- Clean the interior with a damp cloth to remove any dust that might exist. Then wipe with a dry cloth.
- Connect the appliance to the wall socket.

Place the plug into the socket and wait until the appliance starts automatically.

- Let the appliance operate on empty for about 4 hours.
- After addressing these three points, place the products below the load level indicator, engraved on the inner wall of your appliance.

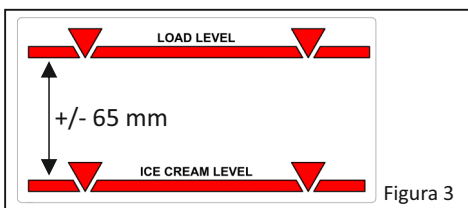

VERY IMPORTANT! Above this level (Load Level - Fig. 3), an acceptable minimum temperature in frozen products is no longer guaranteed.

PLEASE NOTE! In the ARV model never place products on the air ventilation slots (A) represented in the figure below.

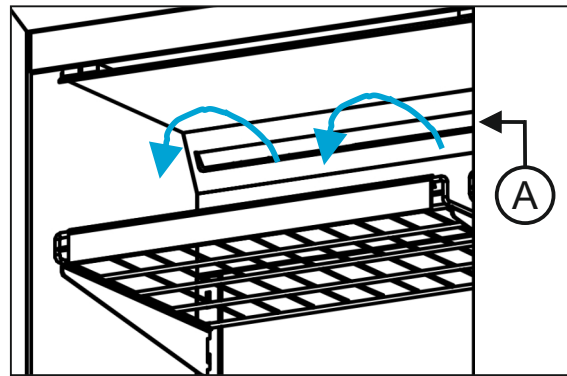

NOTE! As an exhibition booth, these appliances are not intended for freezing fresh products.

2.2 - ELECTRICAL CONNECTION

ATTENTION! The electrical safety of this appliance can only be guaranteed when it is correctly earthed, and it has an independent connection circuit and protection according to the standardisation of each country.

VERY IMPORTANT: This basic safety condition must be observed and, if there are any doubts, the electrical installation must be checked by a certified electrician.

The Manufacturer cannot be held liable for malfunction or damage due to the lack or interruption of the earth connection.

As mentioned in page 2, the appliance should only be connected if it complies with all the safety rules.

2.2.1 - CONNECTION OF LED LIGHTING VIA EXTRA CABLE (OPTIONAL)

The appliance, in its standard version, is equipped with a green interrupter, to switch on and off the interior lighting (example in the figure of point 4.3).

As an option, there is the possibility of using the extra power cable supplied to control the interior lighting, (black electrical cable with a grey sticker marked - LED LIGHTING -) bearing in mind the electrical connection and protection circuit.

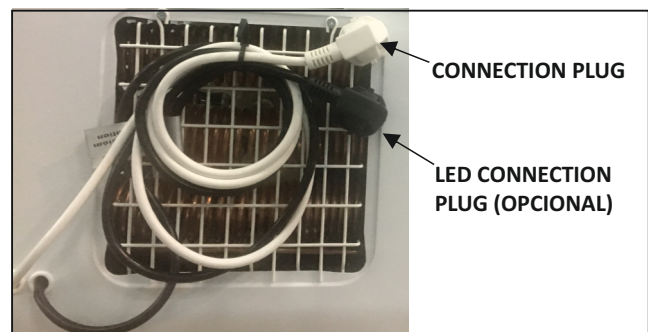

Instructions Manual

⚠ ATTENTION! The extra power cable should be connected to an additional socket, independent from the socket circuit of the freezer. The protection should be adjusted to the power of the lighting circuit.

VERY IMPORTANT: Certify that the appliance is not connected to the lightning circuit.

2.2.2. DATA CABLE

As an option, the appliance can be pre-installed with a communication card and connector for an RS485 connection outlet through a Belden cable.

This system is only applicable to appliances equipped with the **DANFOSS AK-CC 210 A** controller and the **DIXELL XR 77 CX** model.

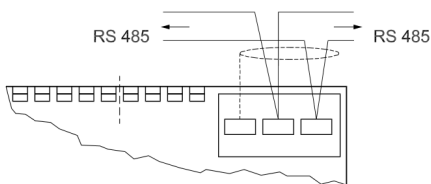

3. INSTALLATION AND COMMISSIONING

⚠ ATTENTION! Before putting your appliance into operation, read point 2 of the previous page carefully.

- Connect the plug to the electrical socket and wait. The appliances equipped with electronic controller have a factory -defined time to start.
- Let the appliance operate for 4 hours, without placing any frozen food in the freezer.
- At the end of 4 hours, place the frozen or chilled goods (DPN model) in the appliance, always below the load level.

VERY IMPORTANT: Respect the storage temperature according to the type of product

Examples of storage temperatures according to the range of the L1 (refrigeration -15/-18) or M1 (cooling +5/-1) appliance - the type of range is to be confirmed on the data plate.

Some reference values are shown below:

- Frozen: -15 °C to -18 °C
- Ice-cream: -20 °C to -22 °C
- Meat: -1°C +2 °C
- Fruit / Vegetables: +6 °C to +12 °C

4. CONTROL PANEL - TEMPERATURE SETTING -

The control panel is located in the front part of your appliance. The appliance can be equipped with a mechanical thermostat or an electronic controller.

4.1. APPLIANCES WITH A MECHANICAL THERMOSTAT



■ Red indicator **⚠** whose function is simply to inform if the interior temperature of the freezer rises above dangerous values for the stored products

NOTE! In the cooling devices (ALFA model), the red indicator is replaced by an orange indicator. This indicates that the appliance is cooling.

■ Green indicator whose whose function is to inform if the appliance is connected to the mains electricity supply **⚡**.

■ Thermometer indicating the temperature in the interior of the freezer.

4.2 APPLIANCES WITH ELECTRONIC TEMPERATURE CONTROL - DIXELL MODEL

The appliance can be equipped with 2 different DIXELL controller models. The **XR02CX** model, used in appliances without defrosting, while the **XR 77 CX** model equips the appliances with automatic defrosting in the D, DPN, D E and DPN E models.

Its main functions are explained below.

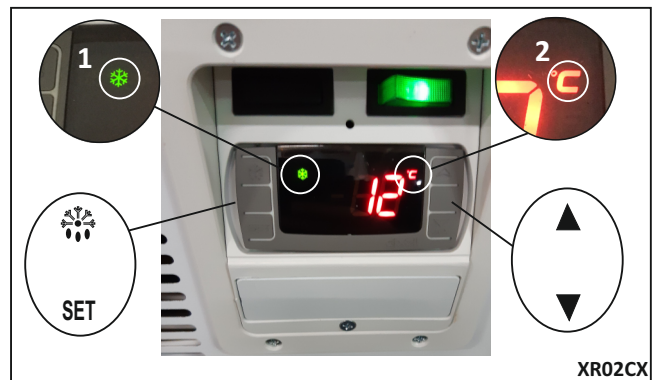



4.2.1 DEFINITION OF THE KEYS

▲▼ key : Increase/Decrease the Setpoint value.

SET key : View and change the Setpoint value

❄️ key : Initiate manual defrosting cycle - Press for 3 seconds (only for XR77 controller)

💡 key : Turn the interior lighting On and Off. (ARV 2.5 DE models only).

🔌 key : Turn the controller On and Off. Option not activated. Contact supplier to activate this option.

IMPORTANT! The appliance is factory-programmed for automatic lighting. Operating hours according to diagram.

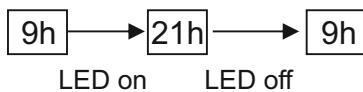

4.2.2. TEMPERATURE SETTING

To change the operating temperature of your appliance, press the **SET** key until the indicator «°C» (represented in the figure above with the number 2) begins flashing. At this moment you can change the average interior temperature of your appliance by increasing or decreasing the values using the **▲** and **▼** keys.

When the new value has been set, click again on the **SET** key, the «°C» led will be set and the new value is memorised.

Information (1)

- **intermittent ❄️ green LED**: means pre-defined minimum waiting time for start up of the compressor.
- **fixed ❄️ green LED**: means appliance is generating cooling.
- **fixed ❄️ yellow LED**: defrosting.
- **intermittent ❄️ yellow LED**: in pump down
- **intermittent ❄️ yellow LED** : Pre-heating the evaporation recipient.

4.2.3. CHANGE OF UNIT OF MEASURE

The preset unit of measure of the electronic temperature controller is °C. If you wish to change to °F, proceed as follows:

- Press the **SET + ▼** keys for approximately 3 seconds, until the «Hy» parameter appears on the XR 02 controller and RTC on the 77CX model.
 - Press the same keys simultaneously again for approximately 8 seconds this time, until the L2 code appears on the XR02CX model and Pr2 on the XR77CX model - access to the general menu of the controller
 - Click on the key **▼** until you find the «CF» parameter and then on **SET** to enter the parameter.
- With the key **▲** select °F (fahrenheit) and click on **SET** again to save the change.
- Lastly, wait until the controller exits the programming mode and returns to the temperature value.

4.2.4 REAL TIME CLOCK SETTING

As already previously mentioned, the controller that equips the appliances, with automatic defrosting (D and DPN) (DE and DE PN) already contains a preset real time clock (RTC). (Only applicable to the XR77CX controller). Nonetheless, the parameters to adjust the clock are indicated below if necessary:

- Press the **SET + ▼** keys for approximately 3 seconds, until the «RTC» parameter appears.
- Click on **SET** to enter the real time clock menu.
- Then and after the Hur parameter has appeared, click on **SET** and define the value of the hour through the **▲** or **▼** keys and click again on **SET** to go on to the adjustment of the value of the minutes and day of the week.
- Lastly, wait until the controller exits the programming mode and returns to the temperature value.

4.2.5. ALARM INFORMATION

- **P1 and P2**: Error in the temperature probe.
Cause: Malfunction of the probe, probe terminal disconnected or not properly connected.
- **HA**: Alarm Temperature.
Cause: Loss of refrigeration performance, replacement of products with a high temperature, change of the SETPOINT value, prolonged power outage or open lids.
- **RTC**: Real time clock setting.
Cause: Appliance disconnected from the power supply for more than 6 months. Discharge of the internal storage battery.

Instructions Manual

⚠ ATTENTION! As previously mentioned, defrosting is factory preset in the XR77CX controller. If the appliance is not put into operation in a period of less than 6 months, you may have to set the time once again.

4.2.6. CHANGE TEMPERATURE RANGE OF APPLIANCE

■ In the DIXELL controller, to change the operating temperature range (DPN or DE PN models), proceed as mentioned in the previous section.

4.2.2 - TEMPERATURE SETTING.

The recommended SETPOINT value is 0 °C

4.3 PANEL WITH ELECTRONIC TEMPERATURE CONTROLLER - DANFOSS MODEL

The DANFOSS AK-CC 210-A electronic temperature controller was specifically designed for our appliances. The controller is also equipped with an automatic defrosting system, used in the D, DPN, DE and DE PN

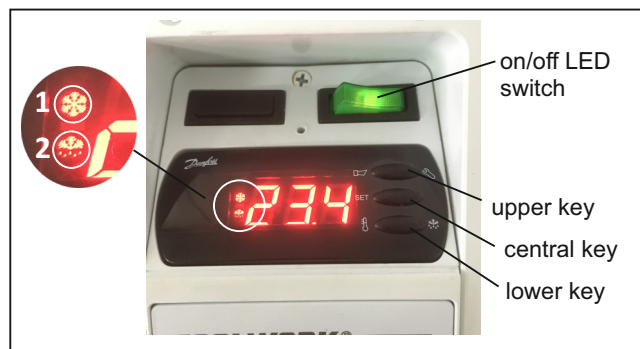

Information (1) and (2)

- led ❄ : means appliance is generating cold.
- led ❄ or -d- : means in defrosting cycle.

4.3.1 DEFINITION OF KEYS

Upper Key:

- Increase the Setpoint value
- Enter the Programming - Press and maintain for 3 seconds.

Central Key:

- View and change the Setpoint value.

Lower Key:

- Decrease the Setpoint value
- Initiate manual defrosting - Press and maintain for 3 seconds.

4.3.2 CHANGE OF TEMPERATURE VALUES

Click on the **central key**, to view the SETPOINT value, and with the **upper or lower key**, define the temperature value that you want.

At the end, click on the **central key** to save the new value.

4.3.3 CHANGE OF TEMPERATURE UNIT

The factory preset unit of measure of the electronic temperature control is °C. If you wish to change it to °F (fahrenheit), proceed as follows:

- Press the **upper** key for 3 to 4 seconds until the word - PS - (password) is shown in the display.
- Press the upper key until you reach the value of 33 and click on the **central key**. At this moment you have entered the parameters of the controller.
- Then click on the lower key until you find the r 05 parameter. Click on the **central key** and then select, with the **upper key**, the °F (fahrenheit) option and click on the central key again to save the value.
- Wait approximately 1 minute and the controller will exit the programming mode automatically.

4.3.4. CHANGE TEMPERATURE RANGE OF APPLIANCE

All the DPN and DE PN model appliances have been preset to work at different temperature ranges. The appliance is predefined to operate as an ice-cream display freezer. However, if you wish to use it as a cooler, there are two options to change the temperature:

- First option: similar to what was mentioned in point 4.3.2
- Second option: change the programming settings. As set out in point 4.3.3, enter the programming mode, select the r39 parameter and change from **OFF** to **ON**. The appliance will automatically change the operating status to values between -1 and +5°C - M1 Class

⚠ NOTE! This function is only available in DPN and DEPN models.

4.3.5 INTERNAL RESET OF THE CONTROLLER / FACTORY SETTINGS

If you have changed parameter values and need to reprogramme the factory values, all you need to do is reset the controller. To that end, proceed as follows:

- Disconnect the appliance from the power socket.
- Press the upper and lower keys simultaneously.
- Switch the appliance on again, maintaining the upper and lower keys pressed. The display will show the factory abbreviation «FAC» (**internal reset and original factory values restored**).
- Lastly, wait until the controller exits the programming mode and returns to the temperature value.

4.3.6. REAL TIME CLOCK SETTING

As already previously mentioned, the controller that equips the appliance is equipped with a real time clock. Nonetheless, the clock (RTC) settings may be adjusted as indicated below.

 **ATTENTION!** If you wish to opt for defrosting at night time, (point 5.1) the clock must always be reset.

- Press the **upper key** for 3 to 4 seconds until - PS - (password) is shown on the display
- Press the upper key until you reach the value of 33 and click on the **central key**. At this moment you have entered the parameters of the controller.
- With the lower key, run through the various parameters until you come to the t07 parameter. Click on the **central key** to enter the parameter and define the hour. Similarly, select the t08 parameter to define the minutes.
Example: local time 11:35 AM (t07= 11 and t08 = 35)
- Lastly, wait until the controller exits the programming mode and returns to the temperature value.

4.3.7. ALARM INFORMATION

When an information alarm is triggered on the controller, all the LEDs of the display flash.

To obtain the error information, click once on the upper key which will indicate the error code. Examples of the most common errors are given below:

- **A1: High temperature alarm.**
Cause: Loss of refrigeration performance, replacement of products with a high temperature, change of the SETPOINT value, prolonged power outage or open lids.
- **E25 or E26:** Malfunction of the temperature probe.
Cause: Malfunction, probe terminal disconnected or not properly connected.
- **E6:** Clock (RTC) setting
Cause: Appliance disconnected from the power supply for more than 1 hour. Discharge of the internal storage battery.
- **A45: Appliance on STAND-BY**
Cause: r12 parameter equal to zero Change to 1 to exit the STAND-BY mode.

 **ATTENTION!** As a final note, please be aware that the temperature indicated on the display of the electronic controller of the appliance is not directly related to the temperature of the products. The temperature probe is placed at the mid-point, fixed on the front wall.

IMPORTANT: Never change the SETPOINT values, without consulting the after-sales service.

5. DEFROSTING

The accumulation of ice inside the appliance depends on 4 key factors:

1. Temperature / Relative Air Humidity (values must not exceed the reference values (+25°C / 60 % - 3L1 class appliance)
2. Type of product placed in the interior.
3. Number of times that the lids are opened.
4. Lids not properly closed.

However, and depending on the 4 points mentioned above, with the aid of a scrapper supplied with the manual, you can scrape any layers of ice that remain, even in appliances with automatic defrosting.

 **ATTENTION!** Even in appliances with automatic (DE model) and semi-automatic (D) defrosting, we recommend, for hygiene reasons, a complete defrosting every six months in the DE model and every three months in the D model (see point 6.2)

IMPORTANT! We do not recommend the use of appliances with defrosting to sell bulk products.

5.1. CLOCK SCHEDULED DEFROSTING





The controllers have a real time clock, which activates the defrosting. To set the time of the defrosting period, follow these steps:

5.1.1 DANFOSS AK-CC 210A CONTROLLER

- Press the **upper key** for 3 to 4 seconds until the word - PS - (password) is shown on the display.
- Press the **upper key** until code 33 appears and then click on the **central key**.
- With the **lower key**, run through the various parameters until you come to the t01 parameter. Click on the **central key** to enter the parameter and with the **upper key**, define the time you intend the defrosting to take place. Click on the **central key** again to save the value and go on to another parameter (t11) to adjust the minutes.

VERY IMPORTANT: If you opt to programme defrosting at night time, you will always have to place the d03 and d18 parameters at zero

5.1.2 DIXELL XR 77 CX CONTROLLER

- Press the SET +  keys for approximately 3 seconds, until the «RTC» parameter appears.
- Press the same keys again for approximately 10 seconds until the «Pr2» parameter appears.
- Click on the  key until you find the parameter that defines the «Ld1» defrosting time and then press SET to enter the menu.
- With the keys  and  define the time you wish defrosting to take place and click on SET to save.
- Lastly, wait for the controller to exit the programming mode automatically.

The preset time defined for defrosting is always night time and starts at 21:00 (Ld1 = 21.0)

5.2 MANUAL DEFROSTING

In appliances without defrosting, disconnect the appliance from the power supply and let the appliance defrost naturally.

Use the sewage drain to facilitate the outflow of water, after the natural defrosting of the appliance. (see figure bellow)

 **ATTENTION!** Do not use mechanical devices or other means to speed up the defrosting process.

NOTE! In models without defrosting the appliance is not equipped with wire protections and trays.

INFORMATION ON THE USE OF THE DRAIN

Use the drain that comes with your appliance. Pull the lid on the left side and in the front part of the appliance outwards, as indicated in the figure.

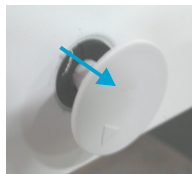

Place a tray below the drain, to place the water stemming from the defrosting of the ice.

An accumulation of ice on the walls means loss of efficiency of the appliance.

Defrost and clean your appliance on a regular basis. Never allow the layer of ice to exceed a thickness of 15 mm.

6. MAINTENANCE / CLEANING

The SUPERMARKET line appliances, with the exception of the vertical cabinet (ARV model) do not require maintenance, only cleaning. You should periodically create a maintenance routine for the finned condenser on the EUREKA line appliances and vertical cabinet (point 6.4)

6.1. EXTERIOR CLEANING

VERY IMPORTANT! Whenever you wish to clean the outer casing of your appliance, never do it directly with water

 **ATTENTION!** The appliances must not be cleaned with cleaning products that contain ammonia or solvents.
Always use neutral soap based products.

- Clean the outer casing regularly with a damp cloth.
Never clean it directly or indirectly with water.
- When cleaning the floor, be careful not to splash water on or in the vicinity of the appliance. Observance of this rule may avoid the risk of serious damage to the appliance.
- In the event of a change in the temperature range from negative to positive values, in the DE PN model (automatic defrosting), pay attention to the floor, next to the motors. There may be an overflow of water from the evaporation tray due to the formation of too much water on the walls of the appliance. (point 6.2.2)

 **ATTENTION!** The defrosted water, stemming from the exit of the deposit can result in a slipping hazard. Clean the floor immediately.

6.2 INTERIOR CLEANING

6.2.1 APPLIANCE WITH SEMI-AUTOMATIC DEFROSTING - «D» MODEL

The appliance with semi-automatic defrosting is a less efficient system, in which the water stemming from defrosting is deposited at the bottom of the appliance.

The appliance should be cleaned every three months.

Prior to cleaning the appliance, proceed as follows:

- Remove the lids of the appliance and place them in a safe location.

 **ATTENTION!** Always use gloves made of cloth so as to avoid touching the inner surface of the glass directly with your fingers.

- Remove all the frozen food and store it in a cold chamber or in another appliance for preservation.

- To simplify the cleaning and removal of ice from the walls, always use manual defrosting in the D and DE models.
Activate the manual defrosting of the appliance.

 **WARNING!** The vertical cabinet, model **ARV 2.5 DE**, is a ventilated cold appliance. In this case there is no frost build up, except in the internal evaporator.
Do not use manual defrosting. Simply remove the mains plug from the socket when you want to clean its interior.

Instructions Manual

MANUAL DEFROSTING ACTIVATION WITH DANFOSS AK/CC 210 A CONTROLLER

Press the **lower key** of the controller for 5 seconds.

NOTE! At the end of the previous operation, check if the display shows the letter -d- at the end of 30 seconds. If this does not happen, repeat the operation.

MANUAL DEFROSTING ACTIVATION WITH DIXELL XR 77 CX CONTROLLER

Press the key  of the controller for 5 seconds, until the yellow LED starts to flash, symbol of defrosting.

■ After defrosting has begun, await approximately 30 minutes. At the end of that time, disconnect the appliance from the power supply or use the controller to place the appliance on STAND-BY.

■ Remove the protection grilles, as shown in the figure below, dragging with them some of the ice that has formed.

INFORMATION! Only the appliances with automatic defrosting are equipped with grilles and trays. To facilitate removal, always remove the trays first and only then the wall protections.

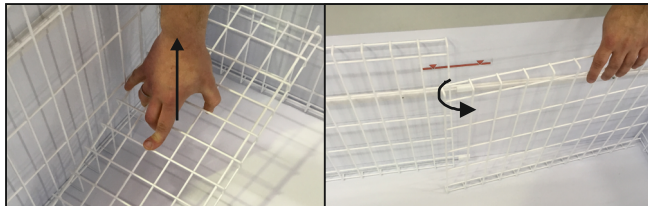

- Clean the water with an absorbent cloth and remove all traces of dirt from inside the appliance.
- Place the clean grilles once again, and then the glass lids.
- Switch on the appliance and let it operate on empty for 3 hours. At the end of this time, place the frozen food back in the freezer.

⚠ ATTENTION! At the end of every cleaning, never forget to place the protection grilles. These guarantee that the frozen food is kept away from the walls during defrosting.

⚠ ATTENTION! As already mentioned at the beginning, do not use mechanical devices or other means to speed up the defrosting process. Remove the ice as recommended, so as to avoid damaging the cooling circuit.

6.2.2 APPLIANCE WITH AUTOMATIC DEFROSTING - «DE» MODEL

The appliance with automatic defrosting is equipped with a water drainage system (figure 4).

This system was designed to collect and dispose of the water from defrosting.

The system is composed of a chute that collects the drops of water from defrosting and sends them to the recipient located above the condenser. The heat of the condenser evaporates the water over time.

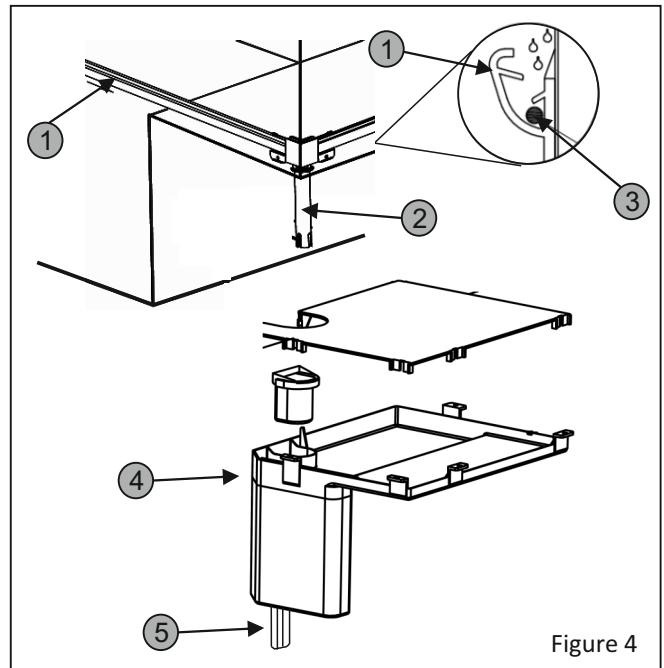

Figure 4

- ① Water drainage chute
- ② Drain
- ③ Electrical Resistance
- ④ Evaporation recipient
- ⑤ Drop tube

VERY IMPORTANT!

The drainage system and drain include an electrical resistance ③ . Never use pointed or sharp-edged objects to clean the drainage chute ① . Use a wet vacuum cleaner, or clean with an absorbent cloth any waste that has been deposited.

⚠ ATTENTION! During automatic defrosting, if water appears below the appliance, it is because the deposit ④ has exceeded the maximum limit. You should clean the surrounding area with a clean cloth.

IMPORTANT! The water from defrosting, which comes from the deposit exit can cause a slipping hazard - clean the floor immediately.

Instructions Manual

⚠ ATTENTION! Do not wash the inside of the freezer with plenty of water. Risk of entry of excess water into the defrosting deposit (4). Always use a damp cloth.

■ The drop tube (5) is provided with a flexible tube to channel the water from defrosting.

NOTE! As an option, you can use a simple tray on the floor, below the flexible tube, or prolong that same tube towards a wastewater line.

According to our studies, based on the climate class of the «3L1» appliance, the possibility of the deposit (4) exceeding the maximum limit is very low. The water will evaporate over time.

6.2.2.1 VERTICAL CABINET (mod. ARV 2.5DE)

The same concept as the previous system 6.2.2, however the water tank is placed at the back of the appliance. The water from defrosting evaporates due to the high pressure heat generated by the compressor.

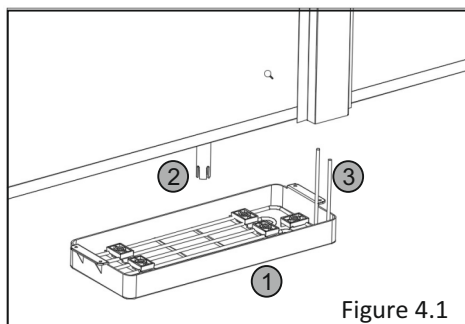

- ① Evaporation recipient
- ② Drain
- ③ High temperature tube for water evaporation.

VERY IMPORTANT:

A complete defrosting of the appliance, for hygiene reasons, is recommended 3 or 4 times a year to eliminate accumulated ice residues and dirt.

This rule is applicable to our entire range of appliances, with the exception of the «DE» (Automatic Defrosting) model which depends on use, whereby once or twice a year is sufficient.

ARV model

As ARV model works with a ventilation system not static as all other our products it is not necessary any special concern about inside ice clean.

6.3. CLEANING OF THE PLASTIC LID FRAMES

The glass lids that equip your appliance slide over a plastic frame.

Clean the **plastic profile where the lid is fitted** on a periodic basis (as needed). Use a slim nozzle of a vacuum cleaner, a brush or compressed air to remove accumulated dirt.

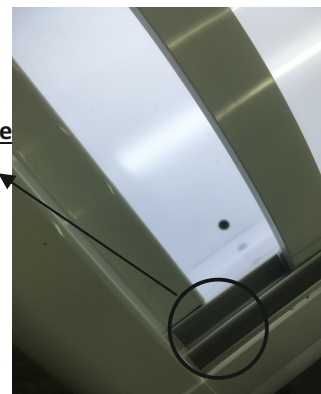

⚠ ATTENTION! The plastic frame where the lids are fitted has a special lubricant to guarantee good slippage. Over time, you may have to lubricate the chute. If necessary, contact the after-sales service.

6.4. CLEANING OF THE CONDENSER

As already mentioned in point 6 of the previous page, the majority of our appliances is equipped with condensers which do not require maintenance.

However, in **Horeca** models, **ARV** model the entire range is equipped with a finning condenser that requires maintenance.

IMPORTANT: Clean the strips of the condenser with the frequency that you must establish, which depends on the degree of cleanliness of the location where you install your

- Remove the 2 screws that secure the rear grille.
- Remove the grille.
- Use the nozzle of the vacuum cleaner compressed air at low pressure or to clean a hard non-metal brush removing all dirt a dust between the compressor fins.

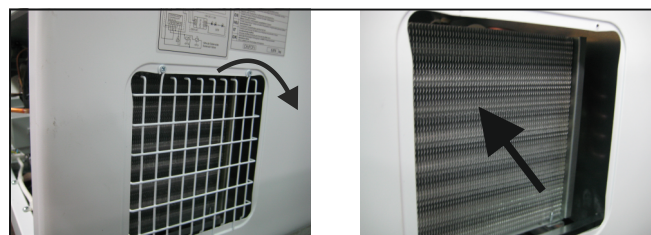

VERY IMPORTANT: On the ARV 2.5DE model, we recommend that the fins of the microchannel condenser are cleaned every 30 days.

The procedure is very simple. It is the same as that of the horeca model, previously mentioned, although in this case the condenser is accessed from the top of the appliance.

Instructions Manual

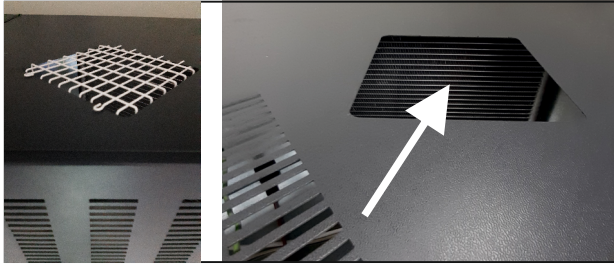

IMPORTANT!
Use protective gloves against cuts from sheets.

6.5. CLEANING OF GLASS

6.5.1. EXTERIOR CLEANING OF GLASS

The glass can be cleaned at any time, even while the appliance is in operation. To clean the glass, it is not necessary to remove the lid.

- Clean the glass with a normal window cleaning detergent. The ideal would be for it to be neutral.

6.5.2. INTERIOR CLEANING OF GLASS

6.6.2. INTERIOR CLEANING OF THE GLASS

When cleaning the inside part of the glass, several precautions have to be taken.

- Remove the lids of the appliance with cotton gloves.
- Leave at ambient room temperature for 20 minutes.
- Clean with a soft cotton cloth, lightly dampened with pure clean and PH neutral water.

⚠ ATTENTION! During the cleaning of the windows, avoid contact with the plastics and rubbers of the appliance. Window cleaning products usually contain solvents that can damage lid seal surfaces and their functionality.

In the event of contact, clean with a damp cloth immediately and then dry the surface very well with a dry cloth.

6.6 REPLACEMENT OF LED LIGHTING

If you want to replace the LED lighting, remove the acrylic profile **(A)** that protects access to the LED strip **(B)**. Unplug the connector **(C)** and remove the strip **(B)**. To install a new LED strip, peel off the film that protects the adhesive backing, plug in the connector and attach the strip from that point along the plate **(D)**.

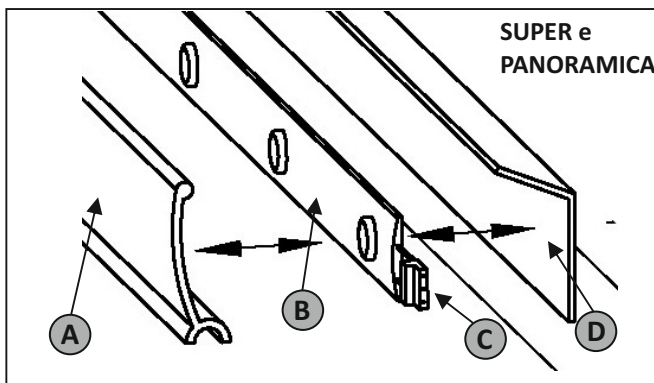

⚠ NOTE! On the SUPER, DUPLA or PANORAMICA TOPO models, to remove the acrylic profile, first remove the fastening screws **(E)**.

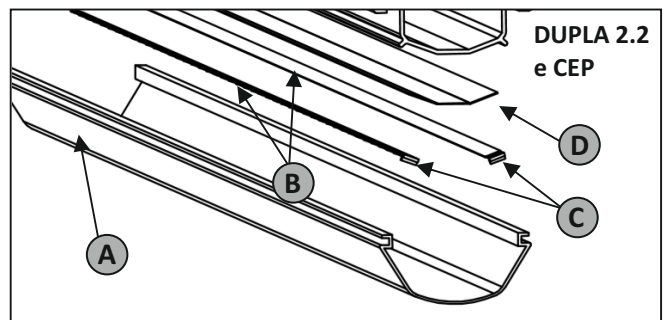
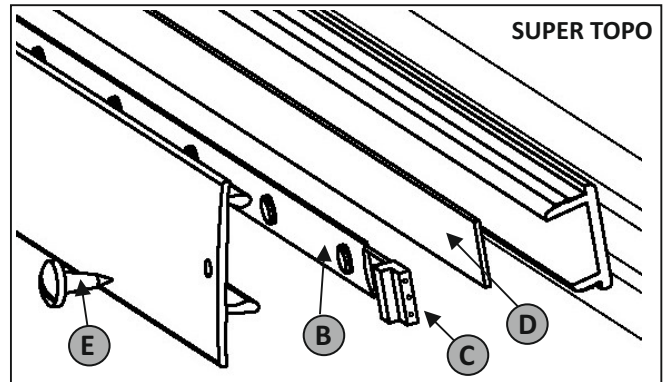

■ The replacement of the LED in the vertical cabinet, model ARV, is done in a different way than the previously mentioned models and it is a little more complex. In this specific case, the appliance is not supplied with the **(C)** connector. The technicians of the after-sales service will have to replace the lighting.

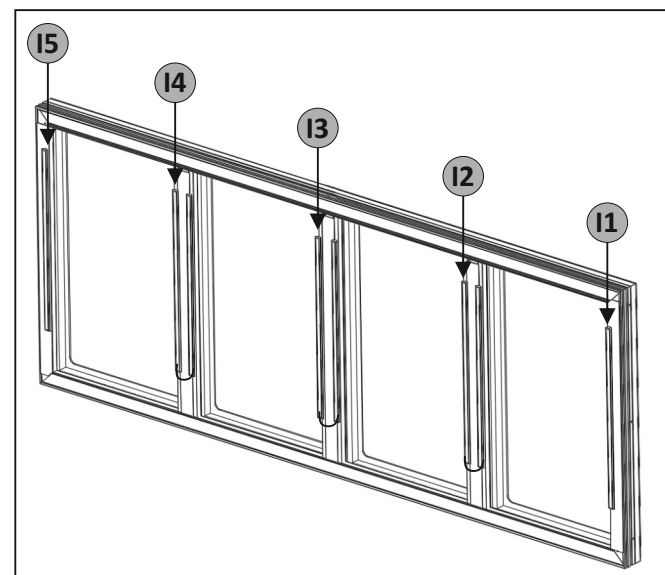

VERY IMPORTANT!

Pay attention to the polarity when connecting the new LED or LED transformer. **ALWAYS KEEP THE SAME WIRE CONNECTION ORDER.**

Instructions Manual

6.7 REPLACING THE LED TRANSFORMER

All appliances with LED lighting have an upstream 110 /240 V - 12V transformer.

VERY IMPORTANT!

The appliances follow very strict normative criteria. When replacing the transformer, as well as any other electrical component, always use the item recommended by the manufacturer.

Changing to a different electrical component may jeopardise the safety and compatibility tests the device has undergone.

7. PACKAGING OF THE PRODUCT / ACCESSORIES

7.1 INTERIOR

7.1.1 APPLIANCES WITHOUT DEFROSTING

The product can be packaged in different ways. The walls of your appliance are equipped with perforated guides (4) for fitting of partitions (3).

You are thus able to partition your products according to your needs.

In addition to the separation partitions (4), there are also baskets (1), and basket partitions (2).

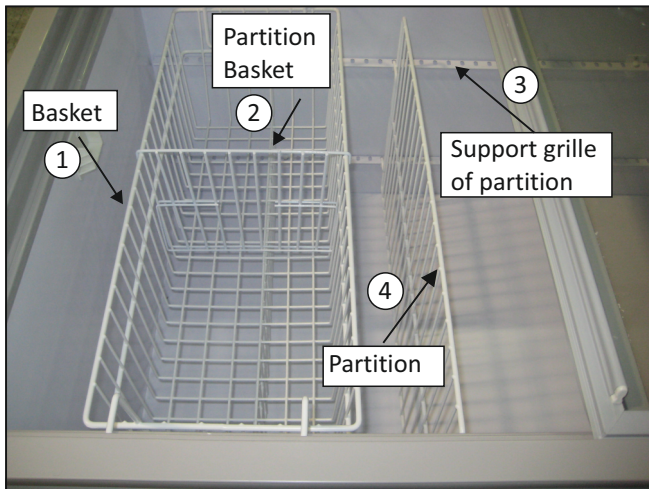

7.1.2 APPLIANCES WITH DEFROSTING

The appliances equipped with defrosting are supplied with tray (5), defrosting protection grilles (6) and transversal partitions (4).

The tray (5) can be applied at different heights from the surface, fixed to the defrosting protection grilles (6).

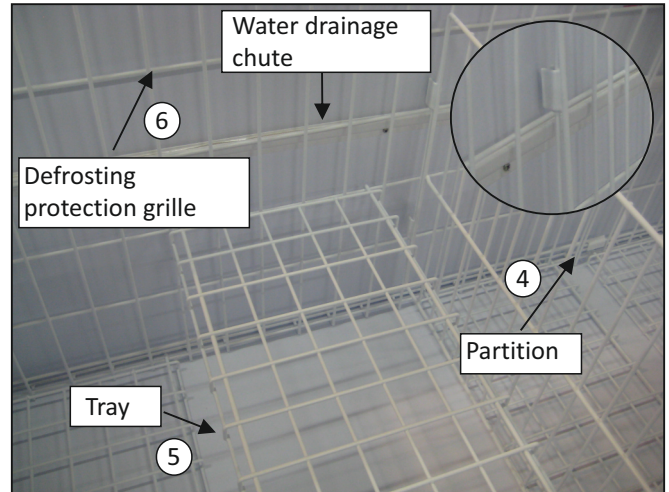

It also permits, in each area between trays, represented below, the placing of partitions and building different compartments for the displayed product. Do not forget that you are also able to raise the tray to the height that you wish.

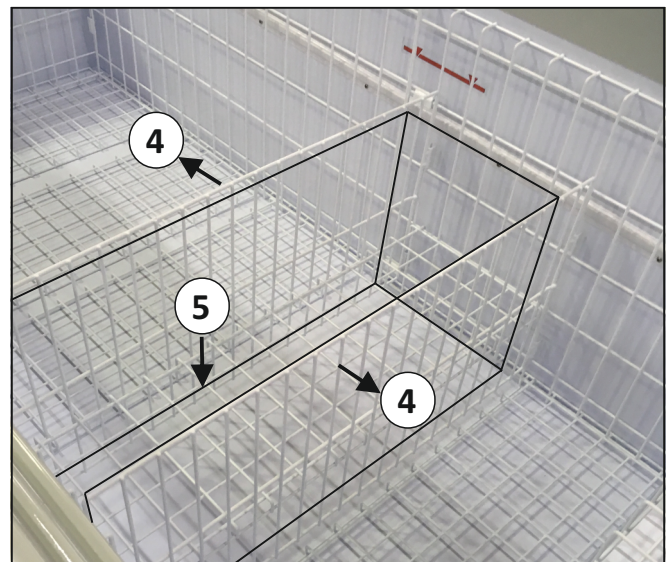

7.2. EXTERIOR

In the PLUG-IN system, there is the possibility of supplying (optional) extra shelves, for external display of other products.

The figure below provides an example of the assembly of shelves.

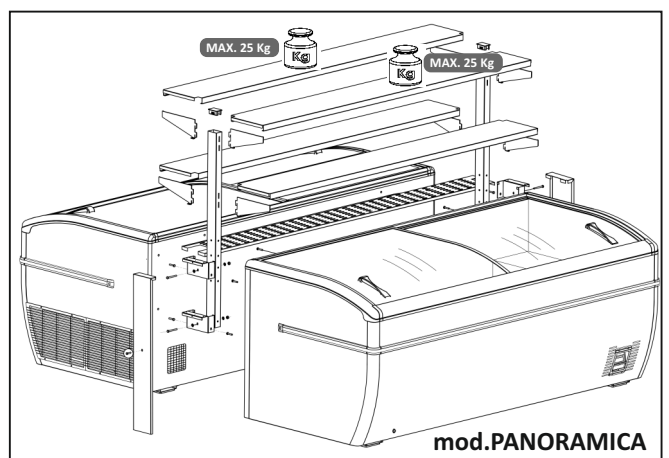

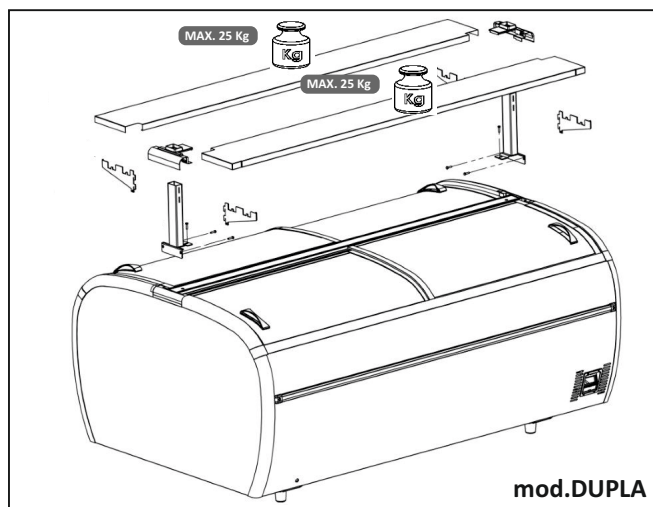
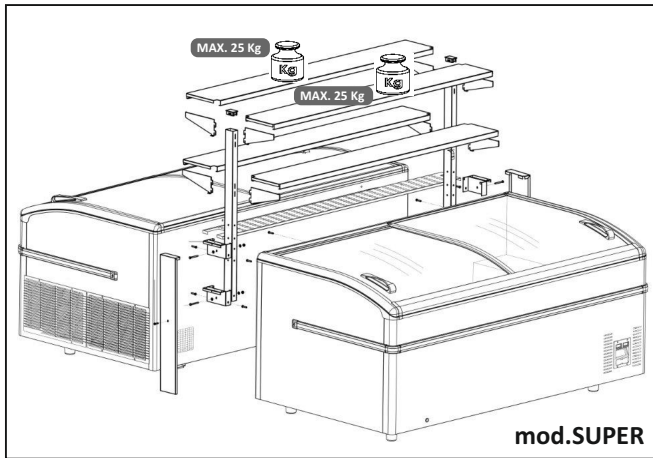

For information on the installation and supply of this material, contact the after-sales service.

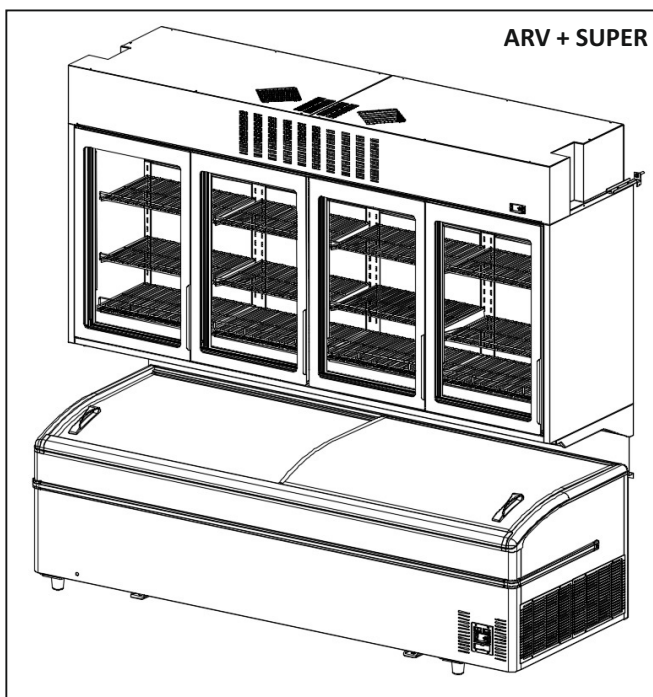

7.3 ARV 2.5 VERTICAL CABINET FIXING BRACKET

7.3.1 ATTACHMENT STRUCTURE

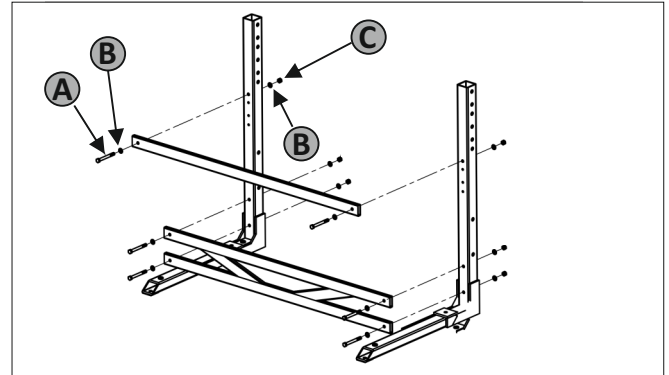

A M12 x 110 mm Screws

B Washer Ø 12

C Nuts M12

7.3.2- TRANSPORT AND RAISING THE APPLIANCE INTO POSITION

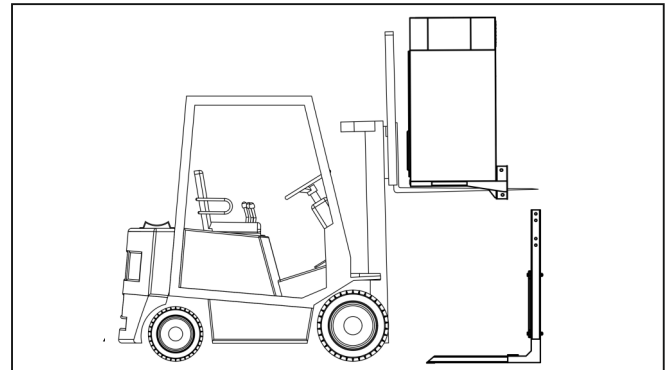

7.3.3- ATTACHMENT OF THE APPLIANCE'S SUPPORT

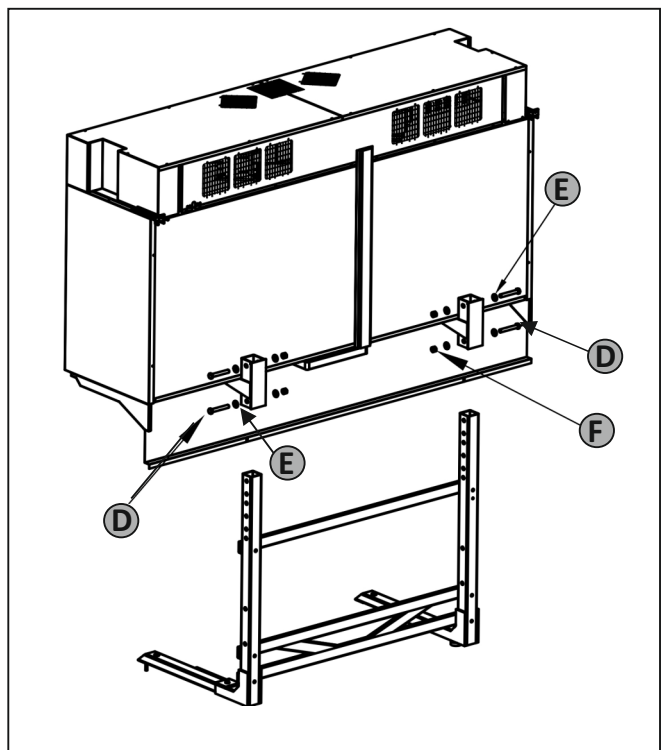

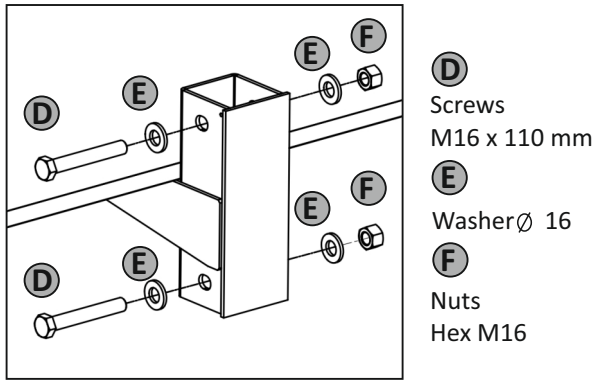

7.3.4- ATTACHMENT OF THE STRUCTURE TO THE WALL

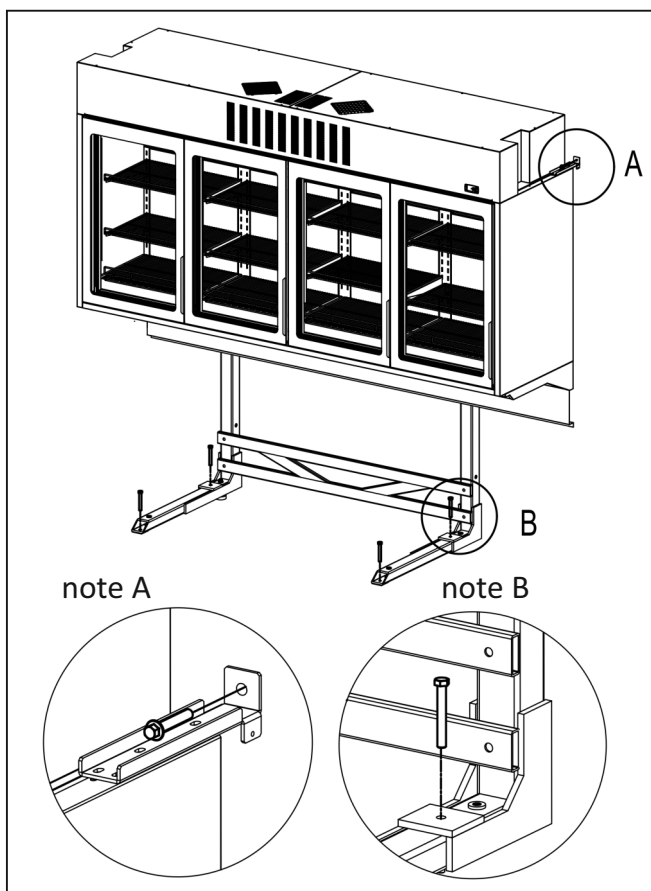

⚠ VERY IMPORTANT:

The support structure of the vertical cabinet (model ARV) must be attached to the floor and the side fixing brackets must be attached to the wall.

8. REGULATION / CERTIFICATION

The appliance you have purchased complies with the following directives/standards

- Low Voltage: **2014/35/UE**
- Electromagnetic compatibility: **2014/30/UE**
- Specific requirements for commercial refrigeration appliances: **EN/IEC 60335-2-89**
- Domestic and similar electrical appliances: **EN/IEC 60335-2-24**
- Electrical Safety: **EN/IEC 60335-1**
- Electromagnetic Compatibility - Requirements for domestic appliances: **EN 55014 / EN 61000 / CISPR 14-1**
- Definitions and Test Criteria: **ISO 23953-1**
- Restriction on the use of hazardous substances **RoHS**
- Waste of electric and electronic equipment **WEEE**
- In this regard, follow the regulations of your country with regard to the elimination of the appliance.

NOTE! This appliance must not be disposed of with your household waste.

